

Product Summary

V _{DS} (V)	R _{DS(on)} (mΩ)	I _D (A) ^d	Q _g (Typ.)
- 30	4.6 at V _{GS} = - 10 V	-20	58 nC
	6.8 at V _{GS} = - 4.5 V		

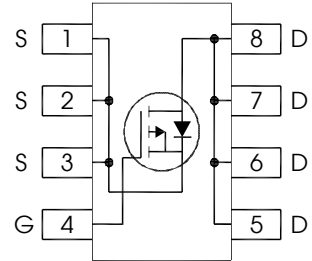

Features

- Industry-standard pinout SOP-8 Package
- Compatible with Existing Surface Mount Techniques
- RoHS Compliant, Halogen-Free
- MSL1, Industrial qualification

Absolute Maximum Ratings

	Parameter	Max.	Units
V _{DS}	Drain-to-Source Voltage	-30	V
V _{GS}	Gate-to-Source Voltage	± 20	
I _D @ T _A = 25°C	Continuous Drain Current, V _{GS} @ 10V	-20	A
I _D @ T _A = 70°C	Continuous Drain Current, V _{GS} @ 10V	-16	
I _{DM}	Pulsed Drain Current ①	-160	
P _D @ T _A = 25°C	Power Dissipation ②	2.5	W
P _D @ T _A = 70°C	Power Dissipation ②	1.6	
	Linear Derating Factor	0.02	W/°C
T _J	Operating Junction and Storage Temperature Range	-55 to + 150	°C
T _{STG}			

Static @ $T_J = 25^\circ\text{C}$ (unless otherwise specified)

	Parameter	Min.	Typ.	Max.	Units	Conditions
BV_{DSS}	Drain-to-Source Breakdown Voltage	-30	—	—	V	$V_{GS} = 0V, I_D = -250\mu A$
$\Delta BV_{DSS}/\Delta T_J$	Breakdown Voltage Temp. Coefficient	—	0.020	—	V/ $^\circ\text{C}$	Reference to $25^\circ\text{C}, I_D = -1mA$
$R_{DS(on)}$	Static Drain-to-Source On-Resistance	—	3.9	4.6	m Ω	$V_{GS} = -10V, I_D = -20A$ ③
		—	5.8	6.8		$V_{GS} = -4.5V, I_D = -16A$ ③
$V_{GS(th)}$	Gate Threshold Voltage	-1.3	-1.8	-2.4	V	$V_{DS} = V_{GS}, I_D = -100\mu A$
$\Delta V_{GS(th)}$	Gate Threshold Voltage Coefficient	—	-5.8	—	mV/ $^\circ\text{C}$	
I_{DSS}	Drain-to-Source Leakage Current	—	—	-1.0	μA	$V_{DS} = -24V, V_{GS} = 0V$
		—	—	-150		$V_{DS} = -24V, V_{GS} = 0V, T_J = 125^\circ\text{C}$
I_{GSS}	Gate-to-Source Forward Leakage	—	—	-100	nA	$V_{GS} = -20V$
	Gate-to-Source Reverse Leakage	—	—	100		$V_{GS} = 20V$
g_{fs}	Forward Transconductance	39	—	—	S	$V_{DS} = -10V, I_D = -16A$
Q_g	Total Gate Charge	—	58	—	nC	$V_{DS} = -15V, V_{GS} = -4.5V, I_D = -16A$
Q_{gs}	Gate-to-Source Charge	—	17	—	nC	$V_{GS} = -10V$
Q_{gd}	Gate-to-Drain Charge	—	28	—		$V_{DS} = -15V$
						$I_D = -16A$
R_G	Gate Resistance	—	2.8	—	Ω	
$t_{d(on)}$	Turn-On Delay Time	—	25	—	ns	$V_{DD} = -15V, V_{GS} = -4.5V$ ③
t_r	Rise Time	—	47	—		$I_D = -1.0A$
$t_{d(off)}$	Turn-Off Delay Time	—	65	—		$R_G = 1.8\Omega$
t_f	Fall Time	—	70	—		See Figs. 20a & 20b
C_{iss}	Input Capacitance	—	5250	—	pF	$V_{GS} = 0V$
C_{oss}	Output Capacitance	—	1300	—		$V_{DS} = -15V$
C_{riss}	Reverse Transfer Capacitance	—	880	—		$f = 1.0MHz$

Avalanche Characteristics

	Parameter	Typ.	Max.	Units
E_{AS}	Single Pulse Avalanche Energy ②	—	630	mJ
I_{AR}	Avalanche Current ①	—	-16	A

Diode Characteristics

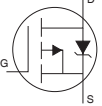
	Parameter	Min.	Typ.	Max.	Units	Conditions
I_S	Continuous Source Current (Body Diode)	—	—	-2.5	A	MOSFET symbol showing the integral reverse p-n junction diode. 
I_{SM}	Pulsed Source Current (Body Diode) ①	—	—	-160		
V_{SD}	Diode Forward Voltage	—	—	-1.2	V	$T_J = 25^\circ\text{C}, I_S = -2.5A, V_{GS} = 0V$ ③
t_{rr}	Reverse Recovery Time	—	71	107	ns	$T_J = 25^\circ\text{C}, I_F = -2.5A, V_{DD} = -24V$
Q_{rr}	Reverse Recovery Charge	—	12	18	nC	$di/dt = 100A/\mu s$ ③

Thermal Resistance

	Parameter	Typ.	Max.	Units
$R_{\theta JL}$	Junction-to-Drain Lead ⑤	—	20	$^\circ\text{C}/W$
$R_{\theta JA}$	Junction-to-Ambient ④	—	50	

Notes:

- ① Repetitive rating; pulse width limited by max. junction temperature.
- ② Starting $T_J = 25^\circ\text{C}, L = 4.9mH, R_G = 25\Omega, I_{AS} = -16A$.
- ③ Pulse width $\leq 400\mu s$; duty cycle $\leq 2\%$.
- ④ When mounted on 1 inch square copper board.
- ⑤ R_θ is measured at T_J of approximately 90°C .

TYPICAL CHARACTERISTICS (25 °C, unless otherwise noted)

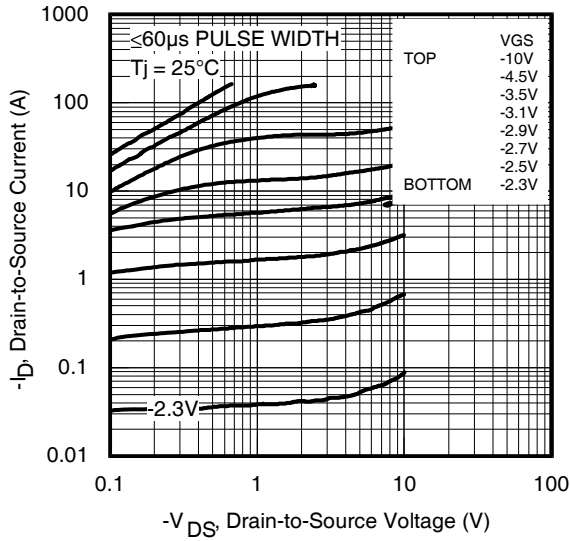

Fig 1. Typical Output Characteristics

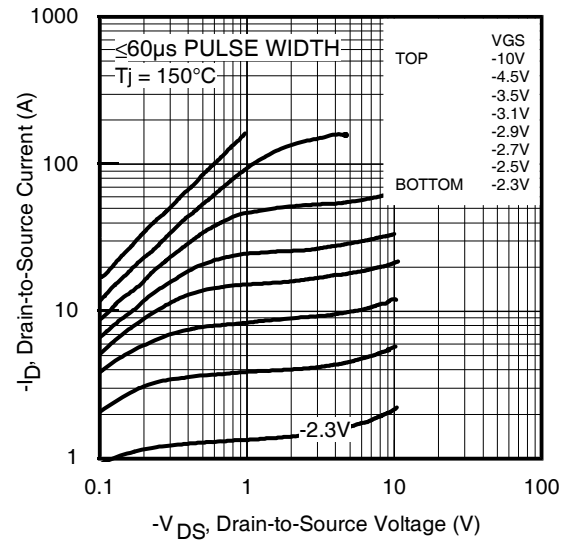

Fig 2. Typical Output Characteristics

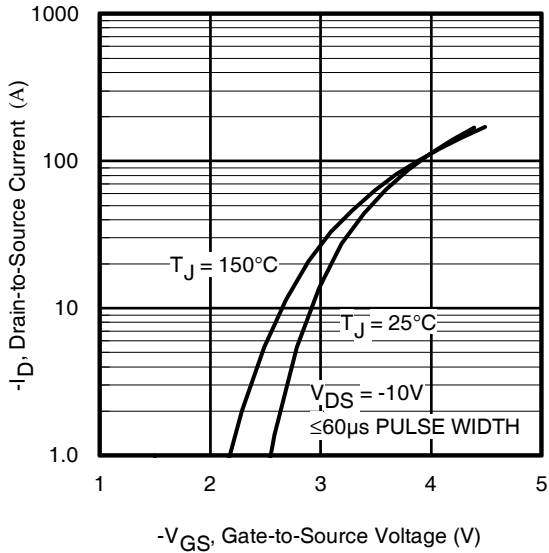

Fig 3. Typical Transfer Characteristics

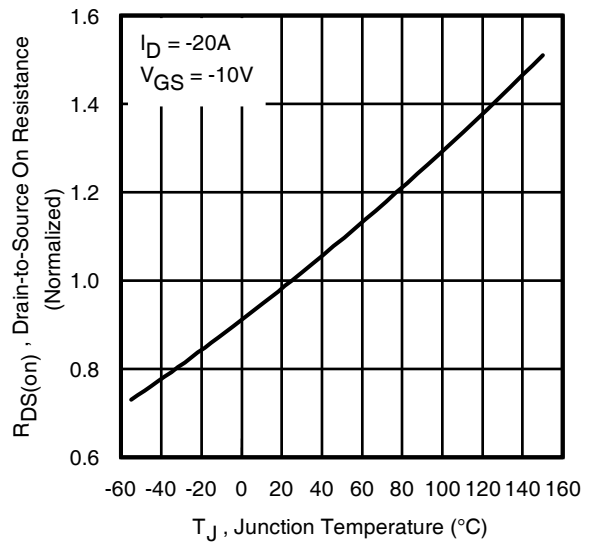

Fig 4. Normalized On-Resistance vs. Temperature

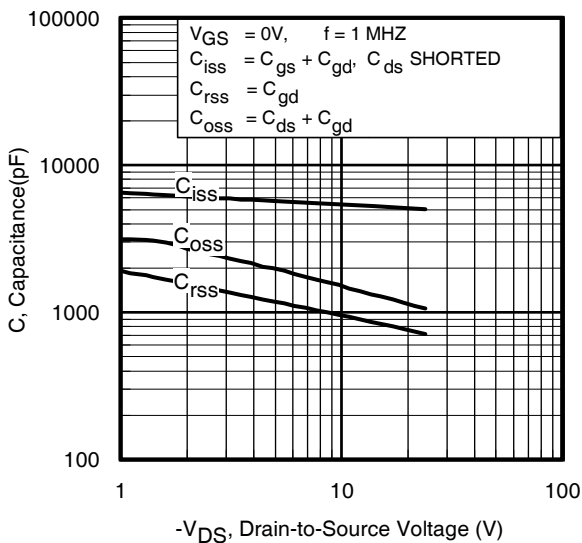

Fig 5. Typical Capacitance vs. Drain-to-Source Voltage

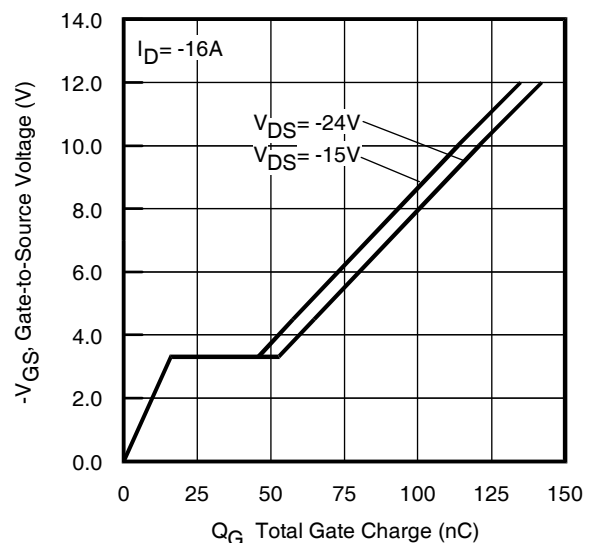

Fig 6. Typical Gate Charge vs. Gate-to-Source Voltage

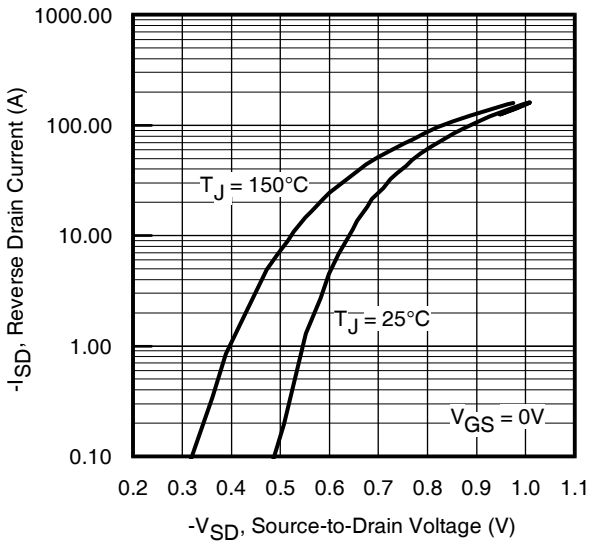

Fig 7. Typical Source-Drain Diode Forward Voltage

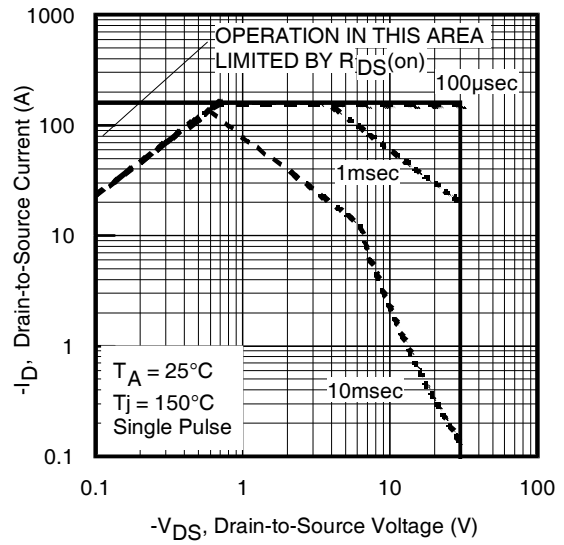

Fig 8. Maximum Safe Operating Area

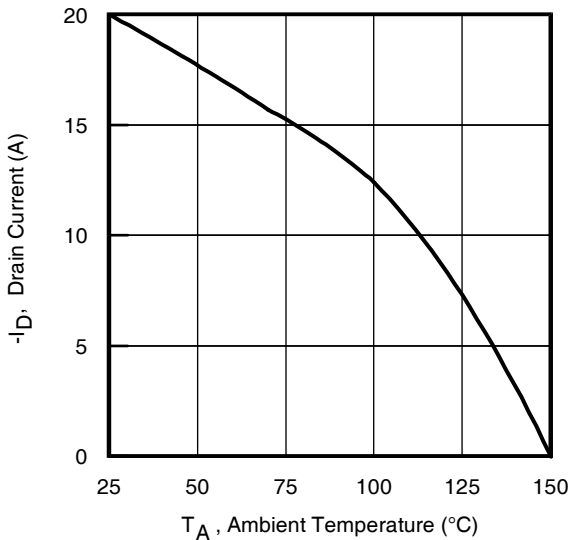

Fig 9. Maximum Drain Current vs. Ambient Temperature

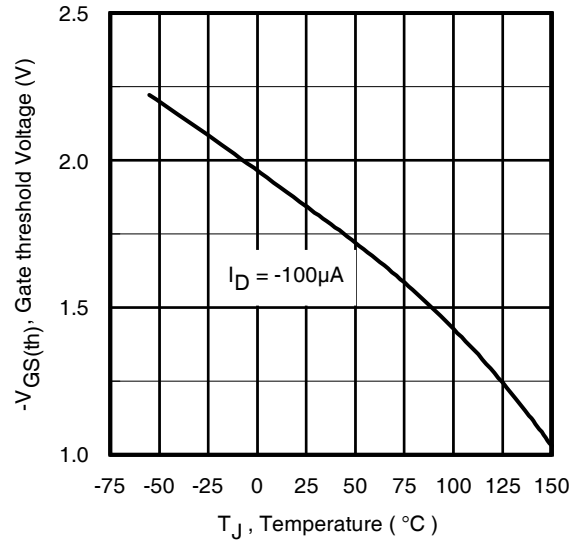

Fig 10. Threshold Voltage vs. Temperature

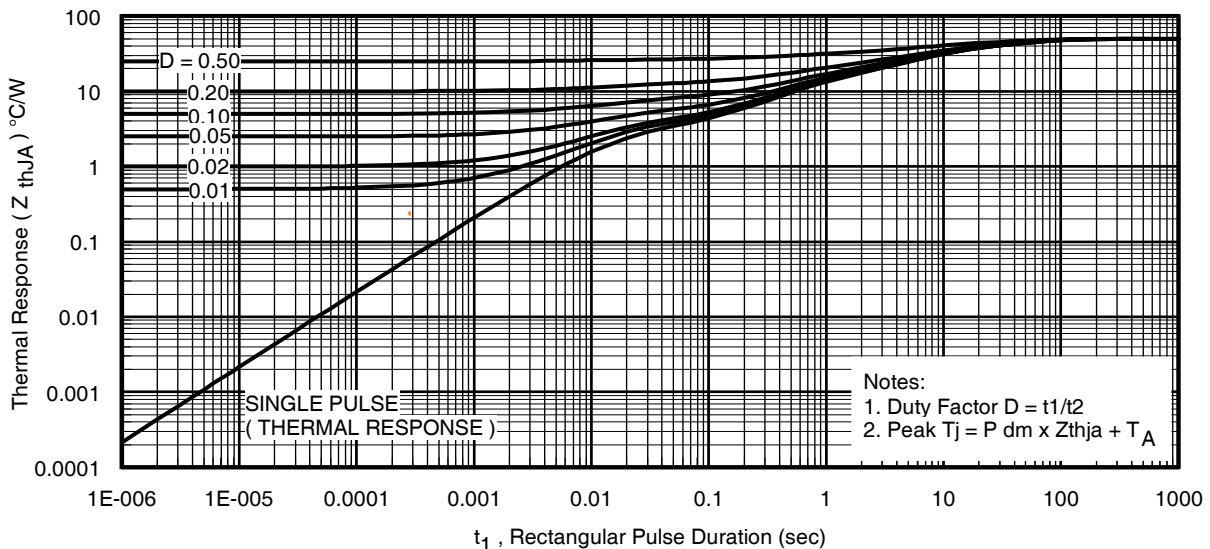

Fig 11. Maximum Effective Transient Thermal Impedance, Junction-to-Ambient

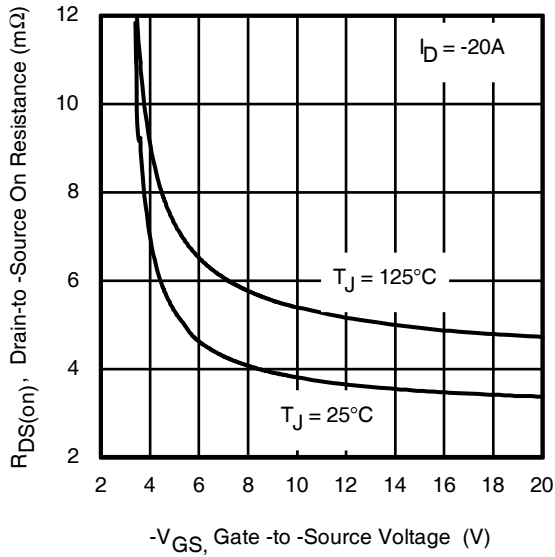

Fig 12. On-Resistance vs. Gate Voltage

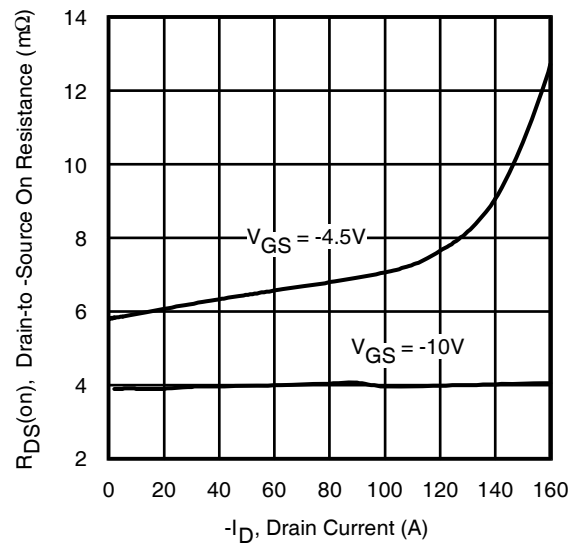

Fig 13. Typical On-Resistance vs. Drain Current

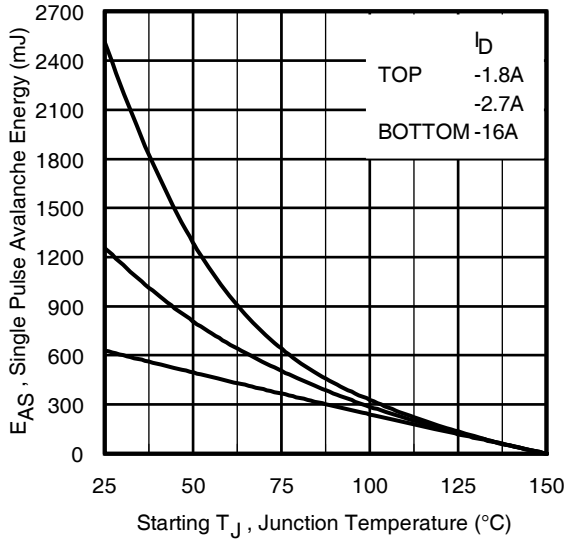

Fig 14. Maximum Avalanche Energy vs. Drain Current

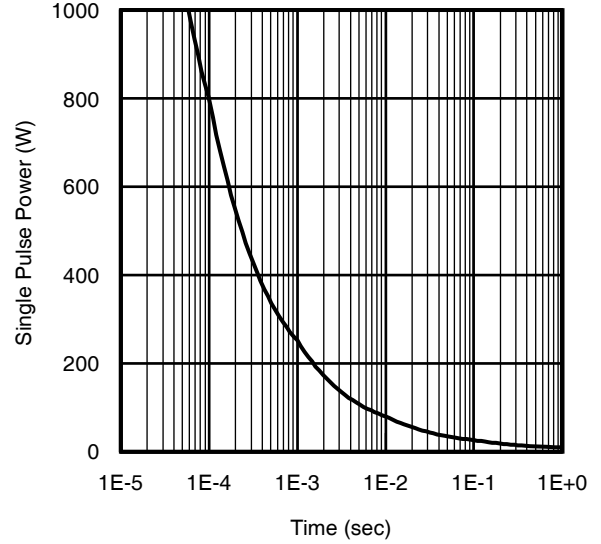

Fig 16. Typical Power vs. Time

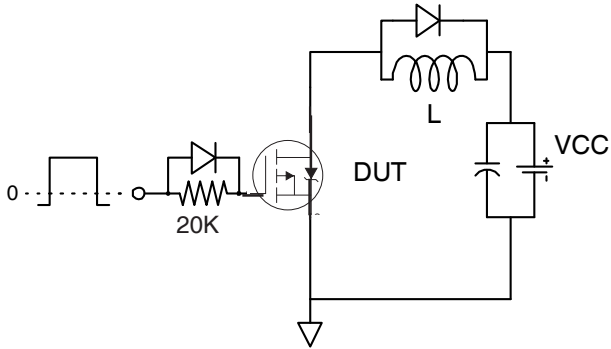

Fig 18a. Gate Charge Test Circuit

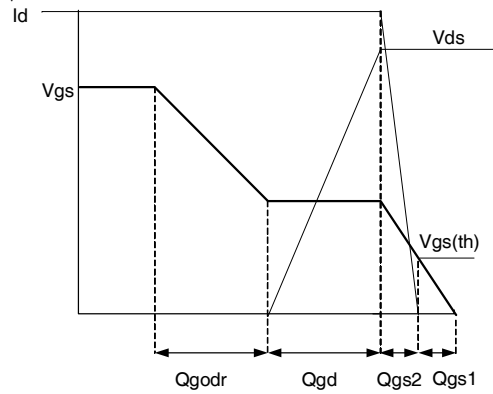

Fig 18b. Gate Charge Waveform

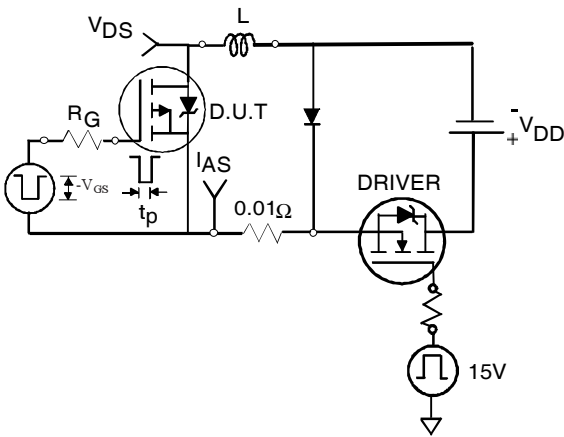

Fig 19a. Unclamped Inductive Test Circuit

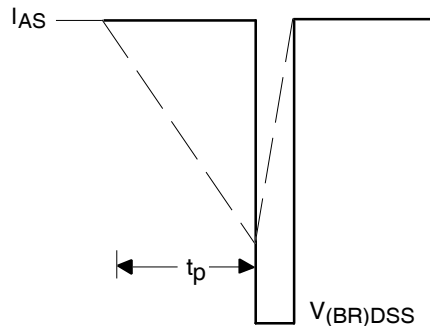

Fig 19b. Unclamped Inductive Waveforms

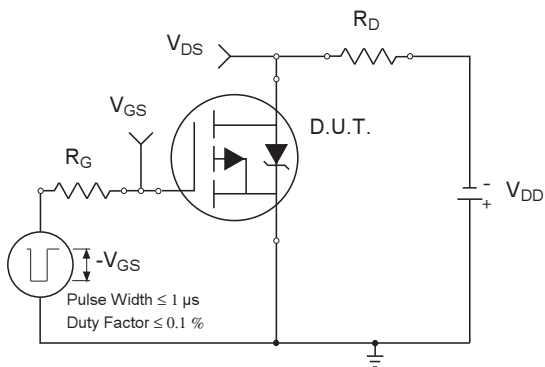

Fig 20a. Switching Time Test Circuit

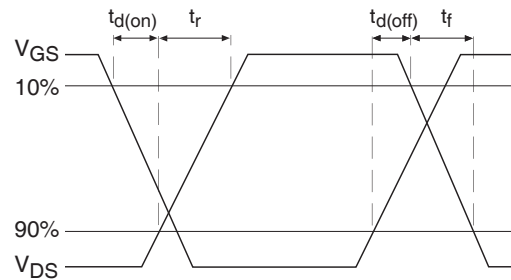
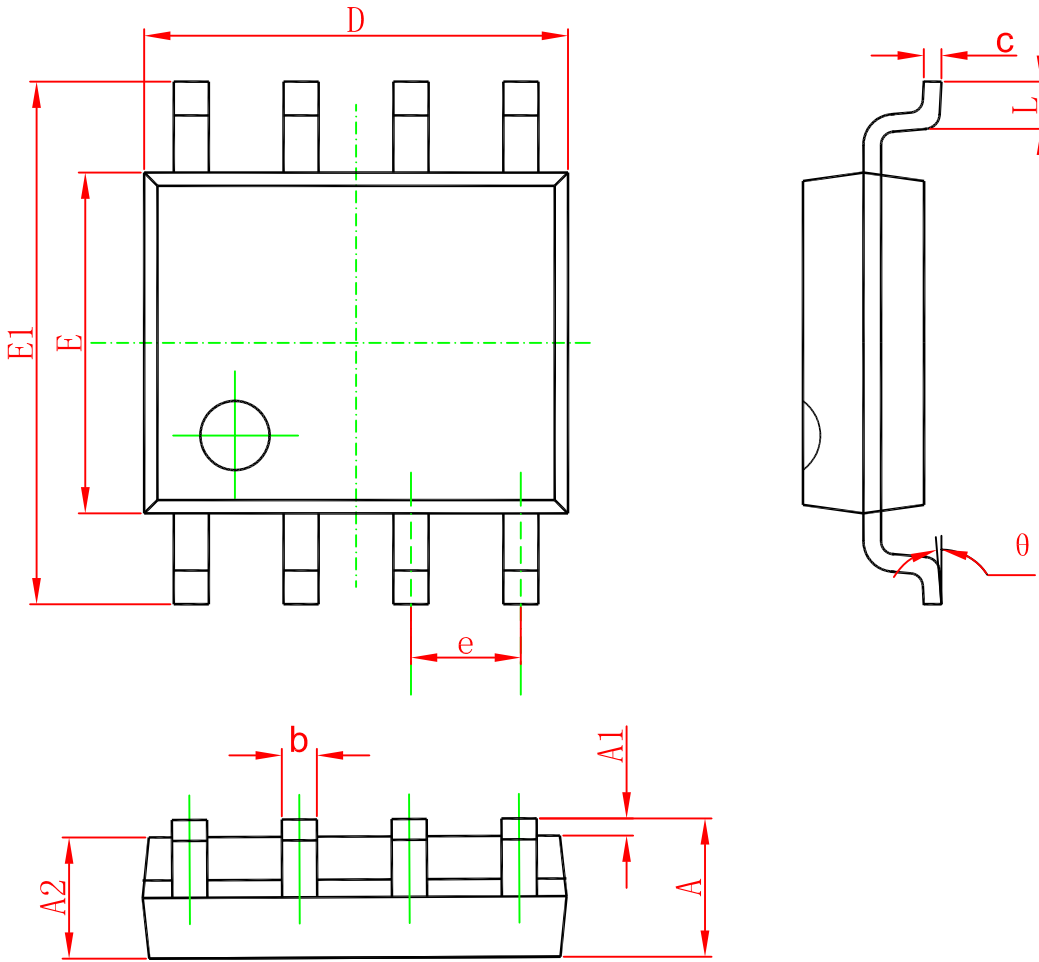

Fig 20b. Switching Time Waveforms

SOP-8



Symbol	Dimensions In Millimeters		Dimensions In Inches	
	Min	Max	Min	Max
A	1.350	1.750	0.053	0.069
A1	0.100	0.250	0.004	0.010
A2	1.350	1.550	0.053	0.061
b	0.330	0.510	0.013	0.020
c	0.170	0.250	0.006	0.010
D	4.700	5.100	0.185	0.200
E	3.800	4.000	0.150	0.157
E1	5.800	6.200	0.228	0.244
e	1.270(BSC)		0.050(BSC)	
L	0.400	1.270	0.016	0.050
θ	0°	8°	0°	8°

Marking

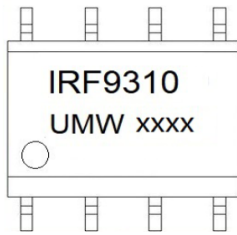

Ordering information

Order code	Package	Baseqty	Deliverymode
UMW IRF9310TR	SOP-8	3000	Tape and reel