

IRF3710S/L

HEXFET® Power MOSFET

- Advanced Process Technology
- Surface Mount (IRF3710S)
- Low-profile through-hole (IRF3710L)
- 175°C Operating Temperature
- Fast Switching
- Fully Avalanche Rated

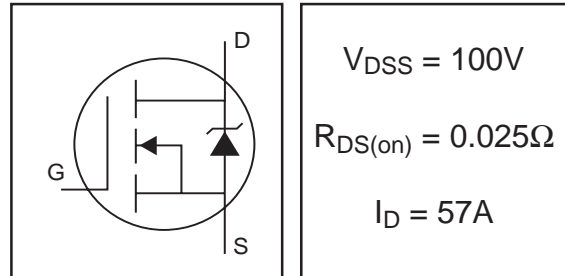

Description

Fifth Generation HEXFETs from International Rectifier utilize advanced processing techniques to achieve extremely low on-resistance per silicon area. This benefit, combined with the fast switching speed and ruggedized device design that HEXFET Power MOSFETs are well known for, provides the designer with an extremely efficient and reliable device for use in a wide variety of applications.

The D²Pak is a surface mount power package capable of accommodating die sizes up to HEX-4. It provides the highest power capability and the lowest possible on-resistance in any existing surface mount package. The D²Pak is suitable for high current applications because of its low internal connection resistance and can dissipate up to 2.0W in a typical surface mount application.

The through-hole version (IRF3710L) is available for low-profile applications.

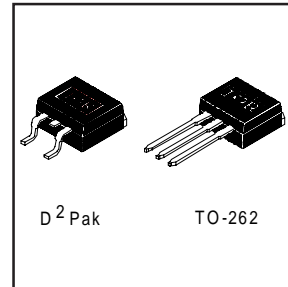

Absolute Maximum Ratings

	Parameter	Max.	Units
$I_D @ T_C = 25^\circ\text{C}$	Continuous Drain Current, $V_{GS} @ 10\text{V}$ ⑤	57	A
$I_D @ T_C = 100^\circ\text{C}$	Continuous Drain Current, $V_{GS} @ 10\text{V}$ ⑤	40	
I_{DM}	Pulsed Drain Current ①⑤	180	
$P_D @ T_A = 25^\circ\text{C}$	Power Dissipation	3.8	W
$P_D @ T_C = 25^\circ\text{C}$	Power Dissipation	200	W
	Linear Derating Factor	1.3	W/°C
V_{GS}	Gate-to-Source Voltage	± 20	V
E_{AS}	Single Pulse Avalanche Energy②⑤	530	mJ
I_{AR}	Avalanche Current①	28	A
E_{AR}	Repetitive Avalanche Energy①	20	mJ
dv/dt	Peak Diode Recovery dv/dt ③⑤	5.0	V/ns
T_J	Operating Junction and	-55 to + 175	°C
T_{STG}	Storage Temperature Range		
	Soldering Temperature, for 10 seconds	300 (1.6mm from case)	

Thermal Resistance

	Parameter	Typ.	Max.	Units
$R_{\theta JC}$	Junction-to-Case	—	0.75	°C/W
$R_{\theta JA}$	Junction-to-Ambient (PCB Mounted, steady-state)**	—	40	

Electrical Characteristics @ $T_J = 25^\circ\text{C}$ (unless otherwise specified)

	Parameter	Min.	Typ.	Max.	Units	Conditions
$V_{(BR)DSS}$	Drain-to-Source Breakdown Voltage	100	—	—	V	$V_{GS} = 0V, I_D = 250\mu A$
$\Delta V_{(BR)DSS}/\Delta T_J$	Breakdown Voltage Temp. Coefficient	—	0.12	—	V/ $^\circ\text{C}$	Reference to $25^\circ\text{C}, I_D = 1\text{mA}$ ⑤
$R_{DS(on)}$	Static Drain-to-Source On-Resistance	—	—	0.025	Ω	$V_{GS} = 10V, I_D = 28A$ ④
$V_{GS(th)}$	Gate Threshold Voltage	2.0	—	4.0	V	$V_{DS} = V_{GS}, I_D = 250\mu A$
g_{fs}	Forward Transconductance	20	—	—	S	$V_{DS} = 25V, I_D = 28A$ ⑤
I_{DSS}	Drain-to-Source Leakage Current	—	—	25	μA	$V_{DS} = 100V, V_{GS} = 0V$
		—	—	250		$V_{DS} = 80V, V_{GS} = 0V, T_J = 150^\circ\text{C}$
I_{GSS}	Gate-to-Source Forward Leakage	—	—	100	nA	$V_{GS} = 20V$
	Gate-to-Source Reverse Leakage	—	—	-100		$V_{GS} = -20V$
Q_g	Total Gate Charge	—	—	190	nC	$I_D = 28A$
Q_{gs}	Gate-to-Source Charge	—	—	26		$V_{DS} = 80V$
Q_{gd}	Gate-to-Drain ("Miller") Charge	—	—	82		$V_{GS} = 10V$, See Fig. 6 and 13 ④ ⑤
$t_{d(on)}$	Turn-On Delay Time	—	14	—	ns	$V_{DD} = 50V$
t_r	Rise Time	—	59	—		$I_D = 28A$
$t_{d(off)}$	Turn-Off Delay Time	—	58	—		$R_G = 2.5\Omega$
t_f	Fall Time	—	48	—		$R_D = 1.7\Omega$, See Fig. 10 ④ ⑤
L_S	Internal Source Inductance	—	7.5	—	nH	Between lead, and center of die contact
C_{iss}	Input Capacitance	—	3000	—	pF	$V_{GS} = 0V$
C_{oss}	Output Capacitance	—	640	—		$V_{DS} = 25V$
C_{rss}	Reverse Transfer Capacitance	—	330	—		$f = 1.0\text{MHz}$, See Fig. 5 ⑤

Source-Drain Ratings and Characteristics

	Parameter	Min.	Typ.	Max.	Units	Conditions
I_S	Continuous Source Current (Body Diode)	—	—	57	A	MOSFET symbol showing the integral reverse p-n junction diode.
I_{SM}	Pulsed Source Current (Body Diode) ① ⑤	—	—	180		
V_{SD}	Diode Forward Voltage	—	—	1.3	V	$T_J = 25^\circ\text{C}, I_S = 28A, V_{GS} = 0V$ ④
t_{rr}	Reverse Recovery Time	—	210	320	ns	$T_J = 25^\circ\text{C}, I_F = 28A$
Q_{rr}	Reverse Recovery Charge	—	1.7	2.6	μC	$di/dt = 100A/\mu s$ ④ ⑤
t_{on}	Forward Turn-On Time	Intrinsic turn-on time is negligible (turn-on is dominated by L_S+L_D)				

Notes:

- ① Repetitive rating; pulse width limited by max. junction temperature. (See fig. 11)
- ② $V_{DD} = 25V$, starting $T_J = 25^\circ\text{C}$, $L = 1.4\text{mH}$
 $R_G = 25\Omega, I_{AS} = 28A$. (See Figure 12)
- ③ $I_{SD} \leq 28A, di/dt \leq 460A/\mu s, V_{DD} \leq V_{(BR)DSS}$,
 $T_J \leq 175^\circ\text{C}$
- ④ Pulse width $\leq 300\mu s$; duty cycle $\leq 2\%$.
- ⑤ Uses IRF3710 data and test conditions

** When mounted on FR-4 board using minimum recommended footprint.

For recommended footprint and soldering techniques refer to application note #AN-994.

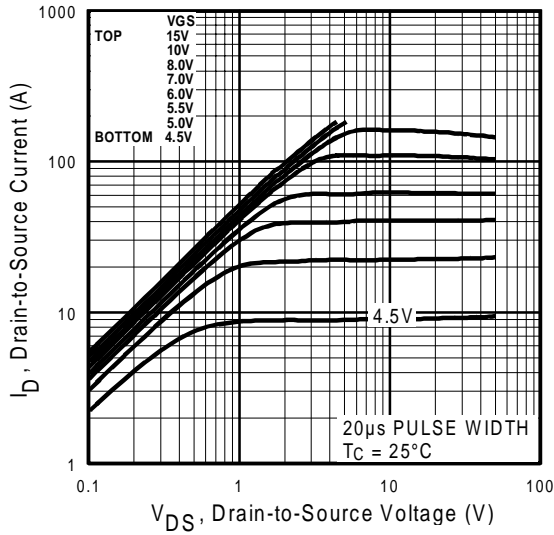

Fig 1. Typical Output Characteristics

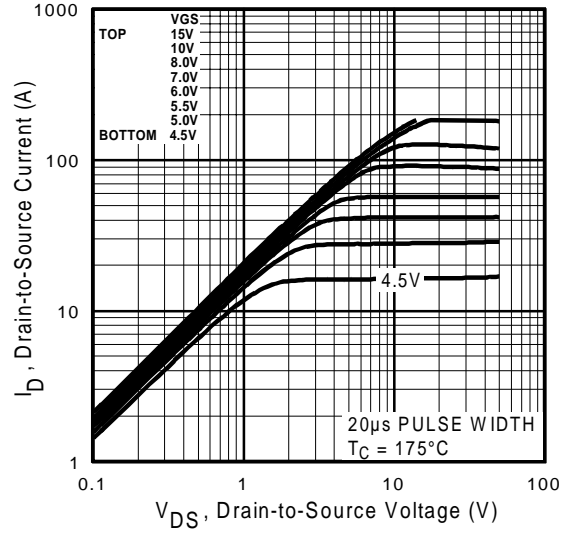

Fig 2. Typical Output Characteristics

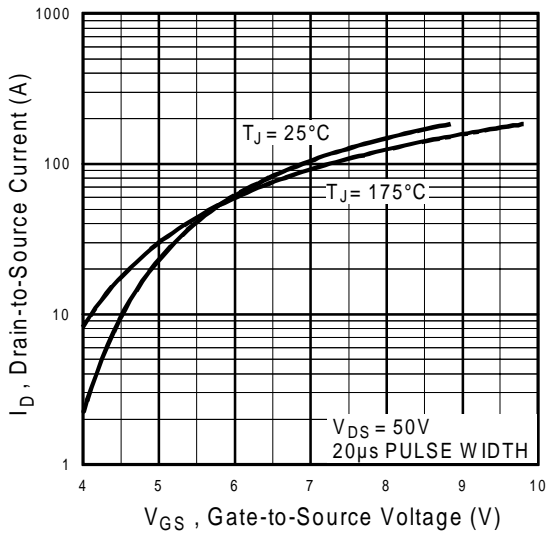

Fig 3. Typical Transfer Characteristics

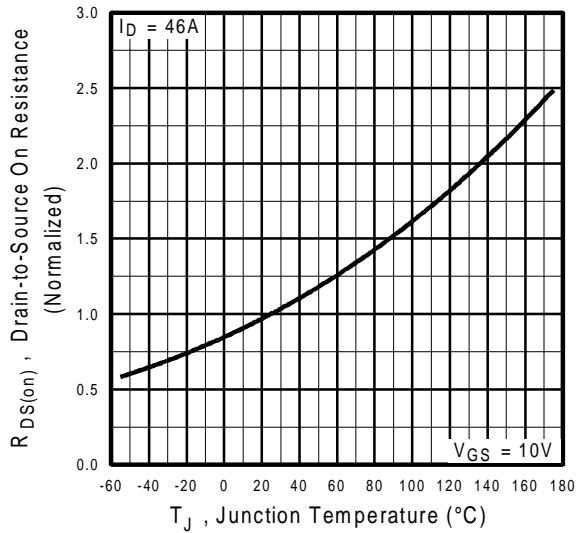

Fig 4. Normalized On-Resistance Vs. Temperature

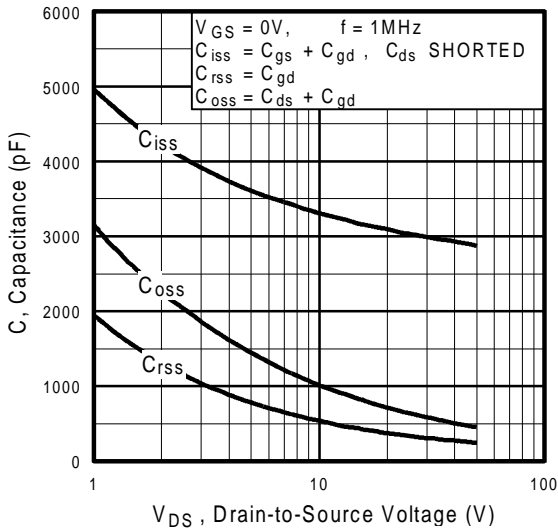

Fig 5. Typical Capacitance Vs. Drain-to-Source Voltage

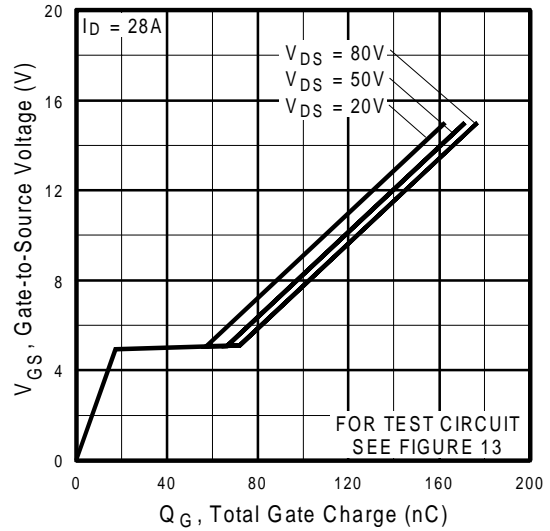

Fig 6. Typical Gate Charge Vs. Gate-to-Source Voltage

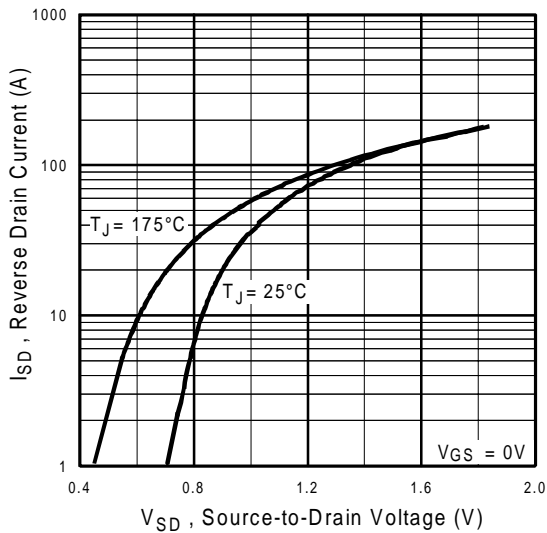

Fig 7. Typical Source-Drain Diode Forward Voltage

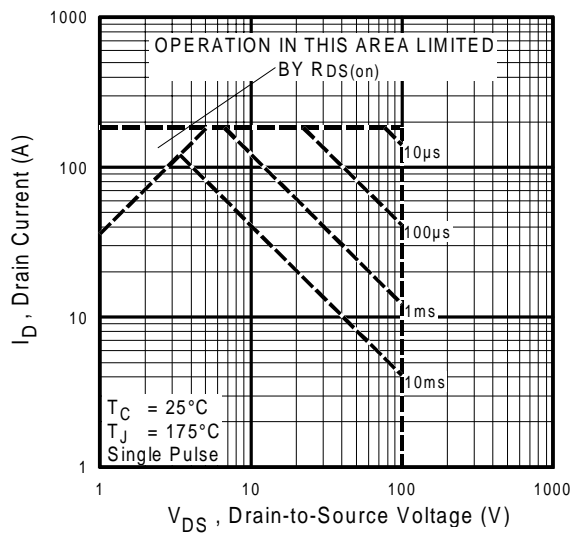

Fig 8. Maximum Safe Operating Area

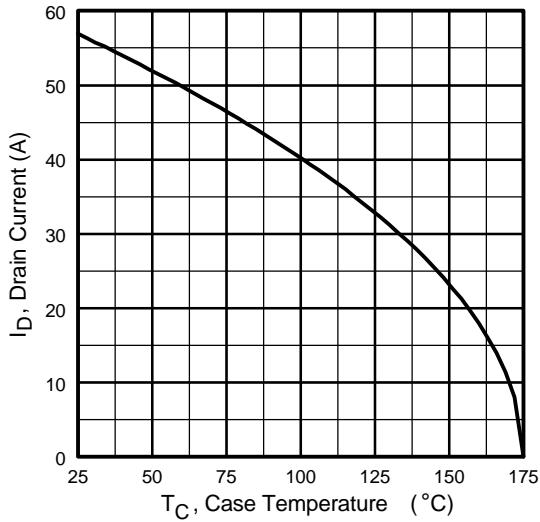

Fig 9. Maximum Drain Current Vs. Case Temperature

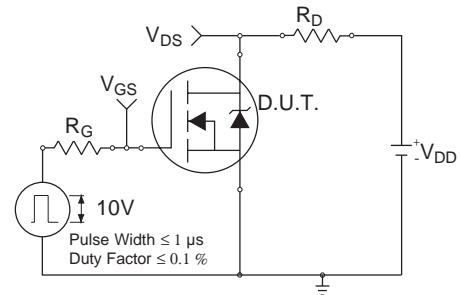

Fig 10a. Switching Time Test Circuit

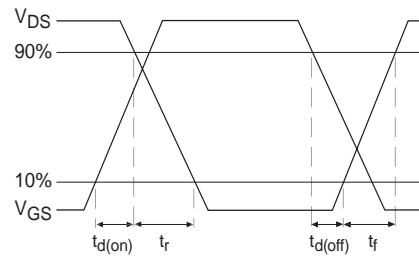

Fig 10b. Switching Time Waveforms

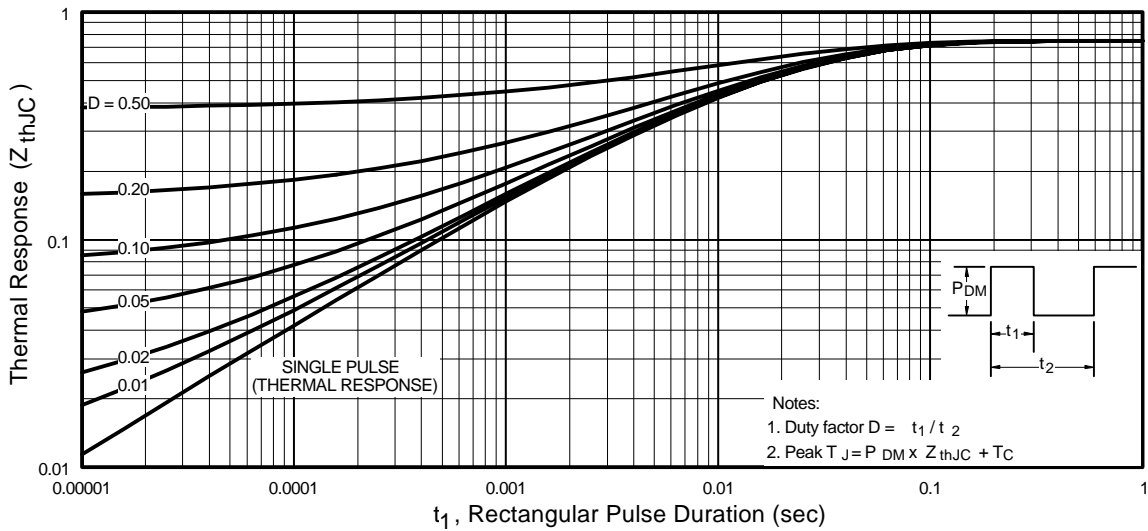

Fig 11. Maximum Effective Transient Thermal Impedance, Junction-to-Case

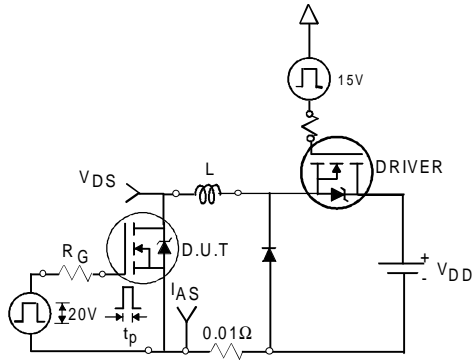

Fig 12a. Unclamped Inductive Test Circuit

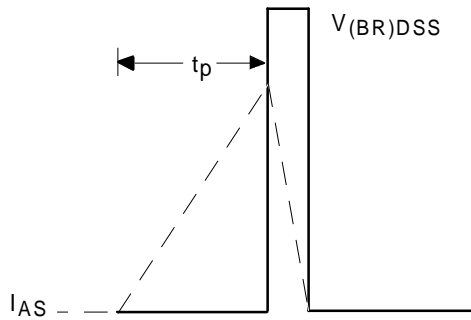

Fig 12b. Unclamped Inductive Waveforms

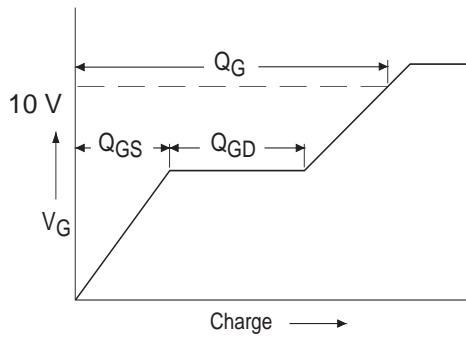

Fig 13a. Basic Gate Charge Waveform

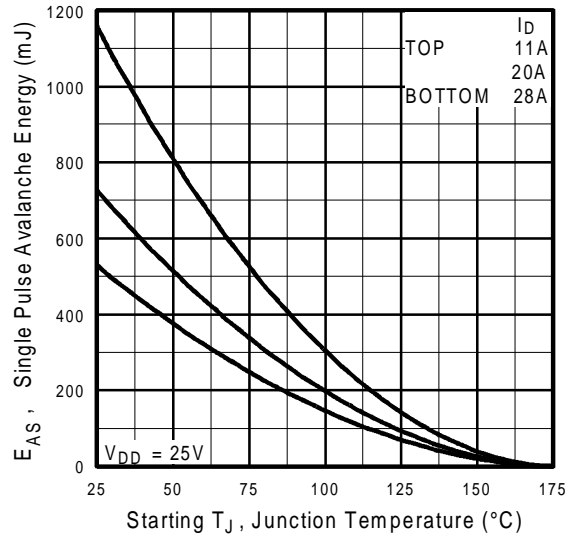

Fig 12c. Maximum Avalanche Energy Vs. Drain Current

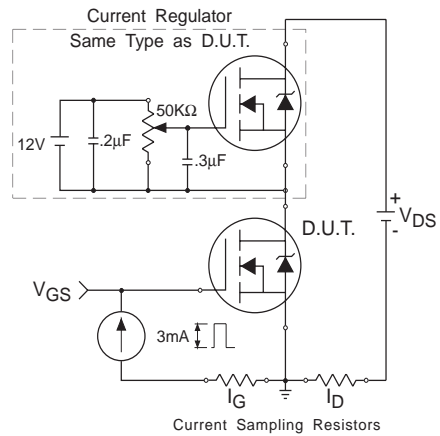
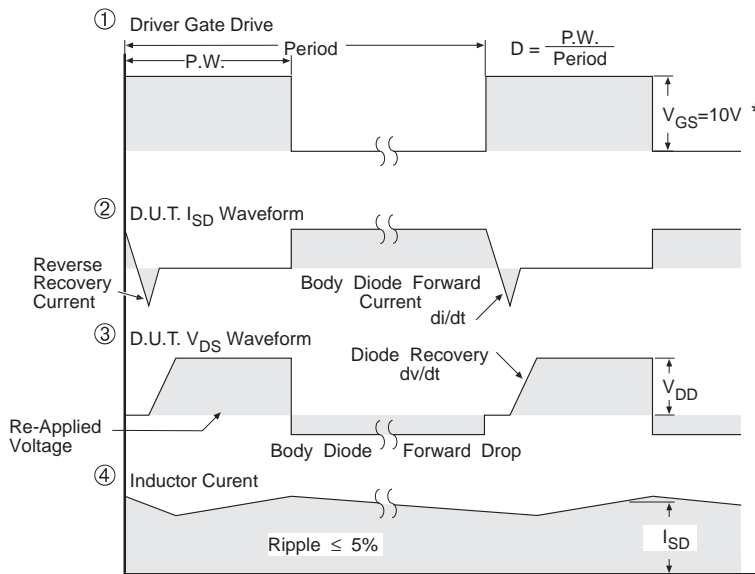

Fig 13b. Gate Charge Test Circuit

Peak Diode Recovery dv/dt Test Circuit



* $V_{GS} = 5V$ for Logic Level Devices

Fig 14. For N-Channel HEXFETS

IRF3710S/L

International
IOR Rectifier

D²Pak Package Outline



Part Marking Information

D²Pak

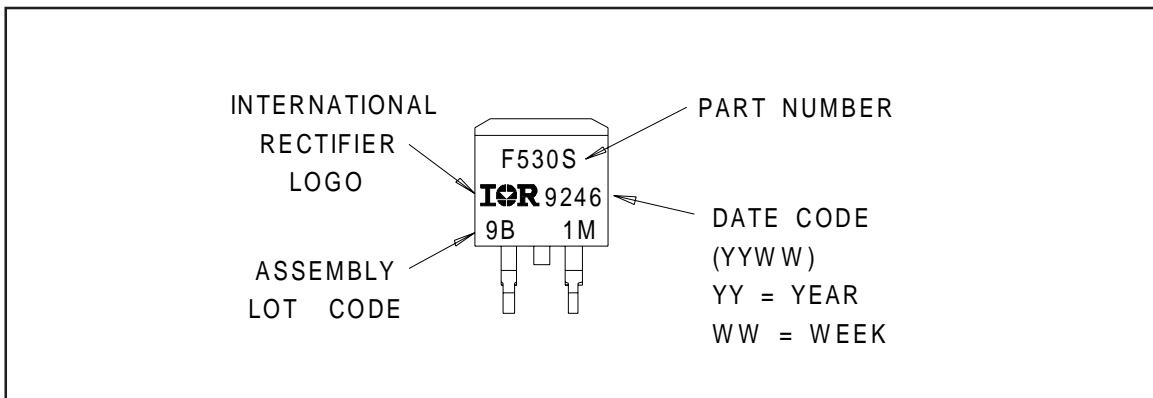

Package Outline

TO-262 Outline



Part Marking Information

TO-262

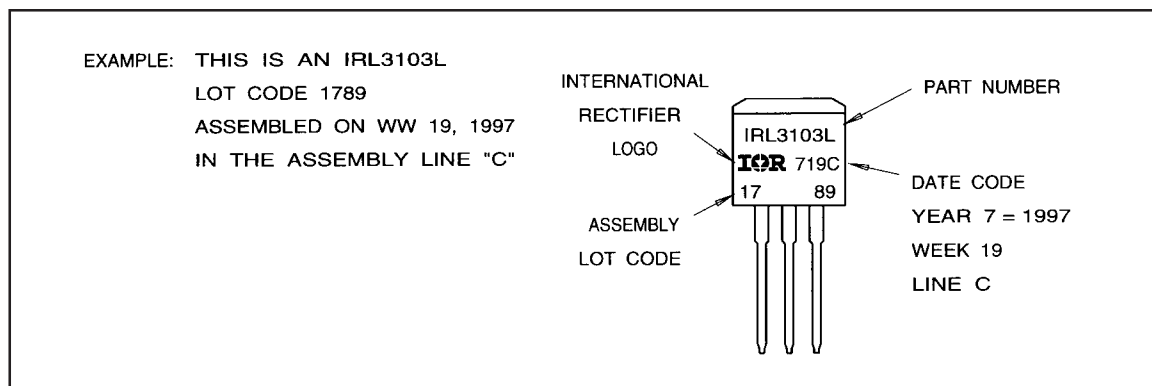

IRF3710S/L

International
IR Rectifier

Tape & Reel Information D²Pak

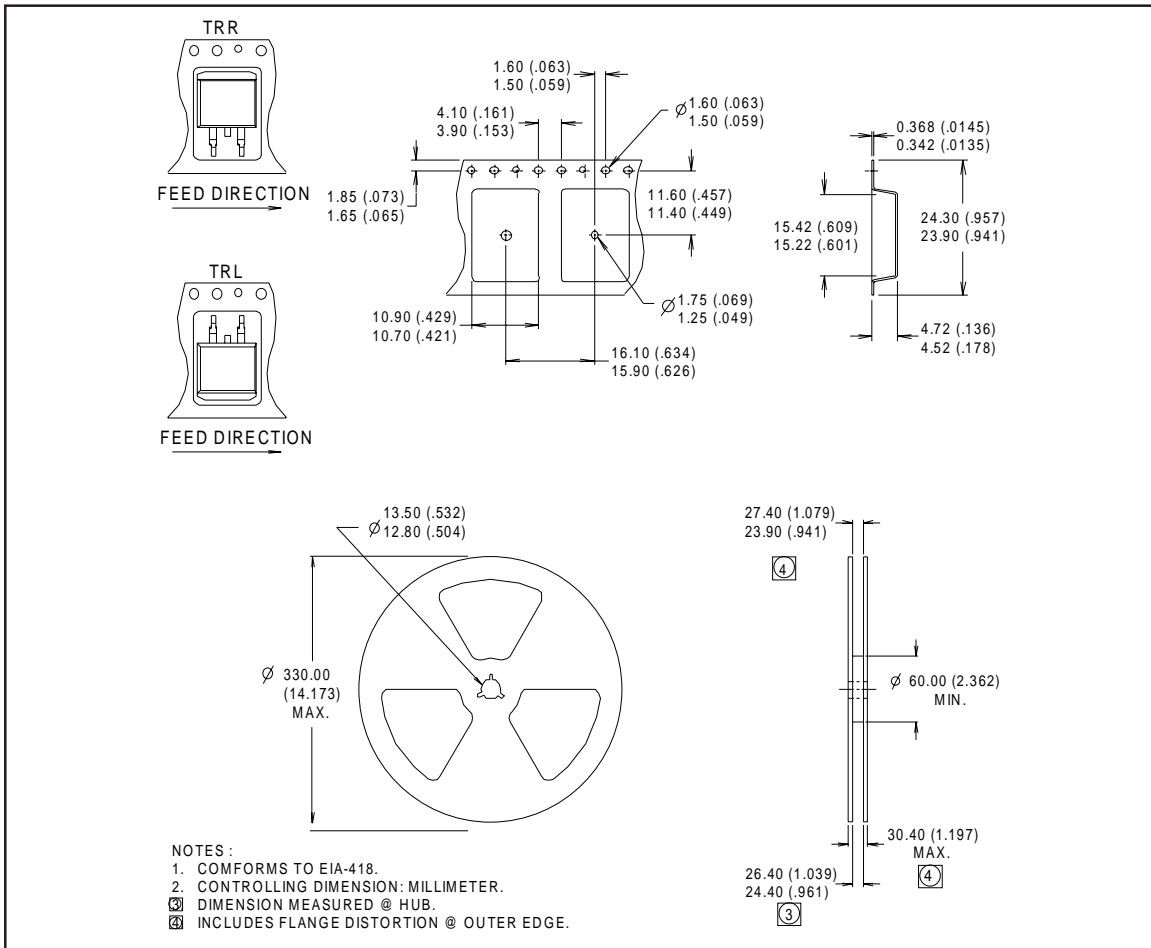

International
IR Rectifier

WORLD HEADQUARTERS: 233 Kansas St., El Segundo, California 90245, Tel: (310) 322 3331

EUROPEAN HEADQUARTERS: Hurst Green, Oxted, Surrey RH8 9BB, UK Tel: ++ 44 1883 732020

IR CANADA: 7321 Victoria Park Ave., Suite 201, Markham, Ontario L3R 2Z8, Tel: (905) 475 1897

IR GERMANY: Saalburgstrasse 157, 61350 Bad Homburg Tel: ++ 49 6172 96590

IR ITALY: Via Liguria 49, 10071 Borgaro, Torino Tel: ++ 39 11 451 0111

IR FAR EAST: K&H Bldg., 2F, 30-4 Nishi-Ikebukuro 3-Chome, Toshima-Ku, Tokyo Japan 171 Tel: 81 3 3983 0086

IR SOUTHEAST ASIA: 315 Outram Road, #10-02 Tan Boon Liat Building, Singapore 0316 Tel: 65 221 8371

<http://www.irf.com/> Data and specifications subject to change without notice. 5/98